

# ENGLISH IP20

Specification of installation in order to ensure safety use ,  
please notice the following Items :

- 1.Read and understand the whole specification .
- 2.Suitable for the use of 220~240 and 50~60Hz
- 3.Please wear gloves as installment and avoid rot on the surface of plating
- 4.Must be installed on the fixed places and checked annually
- 5.Please turn off the lighting source by soft cloth as cleaning prohibited to use rotted detergent
- 6.Please connect with the local sales service center when there are any abnormality

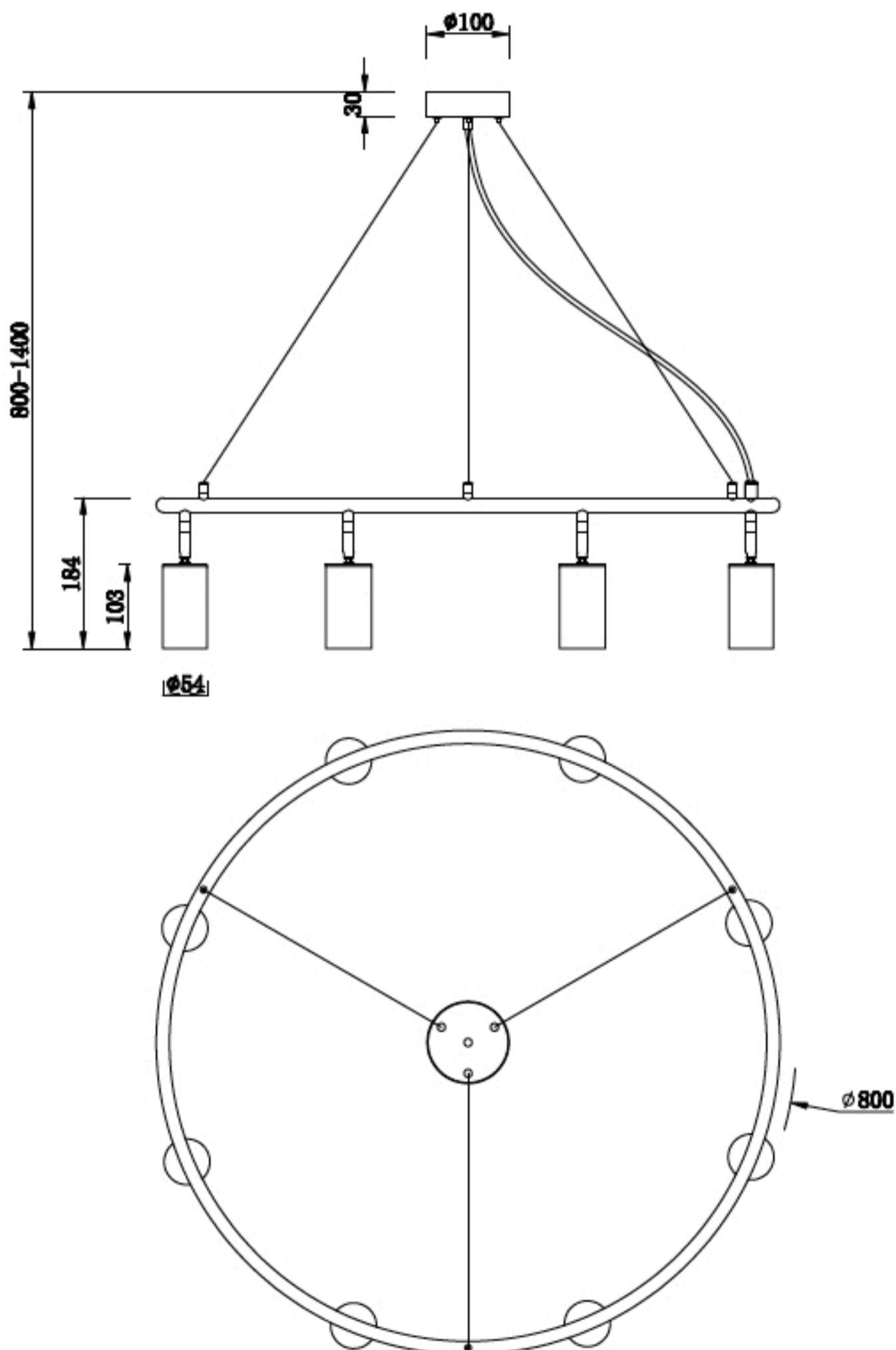

Product coding: CLT 015C8 D800